



YME2100 Series

Grade 1 Exit Devices



An ASSA ABLOY Group brand

ASSA ABLOY

introduction

Yale® YM Series™ exit devices are the ideal choice for economy commercial applications where consistent quality, ease of use and installation are required.

The YME2100(F) rim, YME2110(F) and YME2170(F90) surface vertical rod devices are certified ANSI/BHMA A156.3, Grade 1. Their performance, construction and versatility make them perfect for a variety of facilities.

iso 9001

Designed and manufactured under a certified ISO 9001 quality system.

ansi/bhma

Certified ANSI/BHMA A156.3, Grade 1.



fire listings

YME2100 exit devices are UL-cUL Listed for use on fire doors having a rating up to and including 3-hours.

free wheeling lever trim

YME2100 exit device lever trims feature the unique patented (Patent no. 4,920,773) Free Wheeling lever mechanism. This Free Wheeling trim features a clutch mechanism which allows the lever to float down 60° when operated in the locked condition, greatly improving vandal resistance.



warranty

The YME2100 Series Exit Devices and Trim carry a one-year warranty.

exit device applications

Single Door

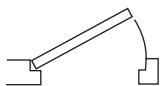

Rim Exit Device

- ANSI/BHMA A156.3 Type 1
- Easy installation
- Flush or wide stile metal, wood or composite doors
- Non-handed
- Exit only or with entry trim

Pairs of Doors



One Rim - One Vertical Rod Exit Device

- An economic solution for light traffic openings
- Flush or wide stile metal, wood or composite doors
- Non-handed
- Emergency exit only

Pairs of Doors with Center Mullion

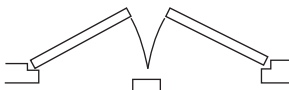

Two Rim Exit Devices - One Removable Mullion

- ANSI/BHMA A156.3 Type 1 and Type 22
- Easy installation
- Flush or wide stile metal, wood or composite doors
- Non-handed
- Exit only or with entry trim

Pairs of Doors or Double Egress Opening

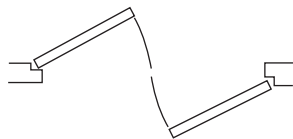

Two Surface Vertical Rod Exit Devices

- ANSI/BHMA A156.3 Type 2
- Two-point latch security
- Flush or wide stile metal, wood or composite doors
- Smoke control or fire exits
- Two-way traffic control

contents

Introduction	2
Finishes	2
Trim Applications	3
Facts and Figures	3
Rim Device	4
Surface Vertical Rod Device	5-6
Outside Trim	7-8
Strikes	9
Accessories	10
Mullions	11-12
Alarms	13-14
Cylinders	14-15
How to Order	16

finishes

ANSI/BHMA Code	Finish Description
612*	Satin Bronze, Clear Coated
613*	Dark Oxidized Satin Bronze, Oil Rubbed
626*	Satin Chrome Plated
630	Satin Stainless Steel
689	Aluminum Painted
691	Light Bronze Painted
693	Black Painted
695	Dark Bronze Painted

*Trim only finish option.



trim applications

ANSI types 1 (Rim) and 2 (Surface Vertical Rod) exit device requirements are met (or exceeded) by YME2100(F), YME2110(F) and YME2170(F90) respectively. Any of these exit devices may be used with any of the trim on the following chart. Trims are charted according to ANSI trim function and illustrations show typical function features, rather than pictorial renderings of the trims listed. Specific trim details are shown on pages 7-8.

Trim	Device (ANSI)	Rim (Type 1)		SVR (Type 2)	
	Options	YME2100(F) (Page 4)		YME2110(F) YME2170(F90) (Pages 5-6)	
ANSI		Function			
01	Exit Only, No Trim/Exit Only, Blank Plate		420F		420F
02	Pull to Open (Dummy Trim)		214F 428F* 429F	448F* 449F*	214F 428F* 429F
03	Key Retracts Latchbolts (NL)		213F 217F 421F	427F 441F	213F 217F 421F
08	Entrance by Lever (Key Locks/Unlocks Lever)		426F 446F		426F 446F
09	Key Unlocks Lever (Key Removable When Locked)		426F*		426F*
14	Lever Always Active (Passage)		428F 448F		428F 448F

*Trims marked with an asterisk on the Application Chart require an easy field change to adapt them for the charted function.

facts and figures

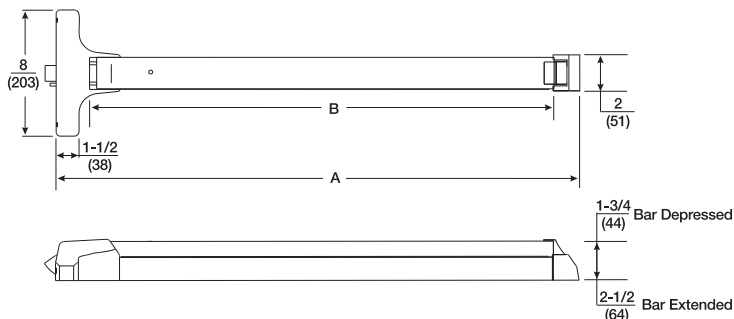

Dimensions are in: inches (mm)

Device Size	"A"	"B"
36"	32-3/8" (82cm)	27" (69cm)
42"	38-3/8" (98cm)	33" (84cm)
48"	44-3/8" (113cm)	39" (99cm)

rim

YME2100(F)

The YME2100(F) is a rim exit device to be used with single doors or pairs of doors constructed of metal, wood or composite materials. The YME2100(F) can be paired with a wide variety of trims to meet many applications.



certification/compliance

UL/cUL Listed: FVSR/FVSR7 - Panic hardware
GXHX/GXHX7 - Fire exit hardware (F)
(4' x 8' single, 8' x 8' pairs, 3 hr.)

ANSI/BHMA Certified: A156.3 Type 1, Grade 1



features

- Designed for wide stile doors
- Non-handed for easy installation
- Steel interlock "E" bracket maintains door-to-mullion relationship in fire-labeled devices
- Deadlocking Pullman latchbolt positively engages roller strike

applications

- Single swing doors
- Pairs of doors (mullion required)
- Metal, wood or composite door materials

specifications

Door Opening Width:	-36 for 30" - 36" (76cm - 91cm) doors. -42 for 36" - 42" (91cm - 107cm) doors. -48 for 42" - 48" (107cm - 122cm) doors.
Door Thickness:	1-3/4" (44mm) standard. Refer to page 10 for other door thicknesses.
Minimum Stile Width:	4-1/2" (114mm).
Projection:	2-1/2" (64mm) active, 1-3/4" (44mm) depressed.
Strike:	757F, 793 optional (double door application).
Trims:	210F series utility trim, 420F series escutcheon trim, 440F series rose trim.
Dogging:	Hex key dogging supplied standard on panic devices.
Finishes:	630, 689, 691, 693, 695.
Options:	Shim Kit #223, Sex Nuts and Bolts.
Warranty:	1-year limited.



surface vertical rod

YME2110(F)

The YME2110(F) is a surface vertical rod exit device to be used on metal, wood or composite pairs of doors up to 8' (fire) and 10' (panic) where two-point latching is desired.

certification/compliance

UL/cUL Listed: FVSR/FVSR7 - Panic hardware
 GXHX/GXHX7 - Fire exit hardware (F)
 (8' x 8' pairs, 3 hr.)

ANSI/BHMA

Certified: A156.3 Type 2, Grade 1

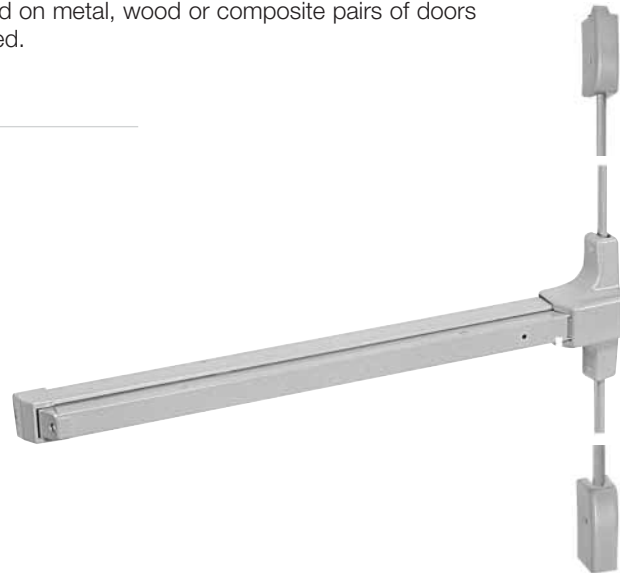

features

- Designed for wide stile and flush doors
- Handed, specify hand (field reversible)
- Positive action linkage on a deadlocking top Pullman bolt
- Simultaneous direct pull bottom deadbolt
- When unlatched, device keeps both bolts retracted until door is shut.

applications

- Pairs of doors
- Double egress
- Metal, wood or composite door materials

specifications

Door Opening Width: -36 for 30" - 36" (76cm - 91cm) doors.
 -42 for 36" - 42" (91cm - 107cm) doors.
 -48 for 42" - 48" (107cm - 122cm) doors.

Door Opening Height: Standard door height 7' (213cm), with the device at 39-5/16" (100cm) from floor.
 Optional heights up to 8' (fire) and 10' (panic) available by using rod extensions.

Door Thickness: 1-3/4" (44mm) standard. Refer to page 10 for other door thicknesses.

Minimum Stile Width: 4-1/2" (114mm).

Projection: 2-1/2" (64mm) active, 1-3/4" (44mm) depressed.

Strike: Top: 791. Bottom: 790.

794 floor strike optional (threshold openings), 702 optional (Bottom Pullman Latch).

Trims: 210F series utility trim, 420F series escutcheon trim, 440F series rose trim.

Dogging: Hex key dogging supplied standard on panic devices.

Finishes: 630, 689, 691, 693, 695.

Options: Shim Kit #224, Sex Nuts and Bolts, Bottom Pullman Latch (panic only).

Warranty: 1-year limited.

YME2170(F90)

The 2170(F90) is a surface vertical rod exit device to be used on wide stile and flush doors up to 10' where two-point latching is desired. A Less Bottom Rod (LBR) option is available.

certification/compliance

UL/cUL Listed: FVSR/FVSR7 - Panic hardware
GXHX/GXHX7 - Fire exit hardware (F) (8' x 10' pairs, 1-1/2 hr.) (8' x 8' pairs, 3 hr.)

ANSI/BHMA

Certified: Certified A156.3 Type 2, Grade 1 **BHMA**
CERTIFIED

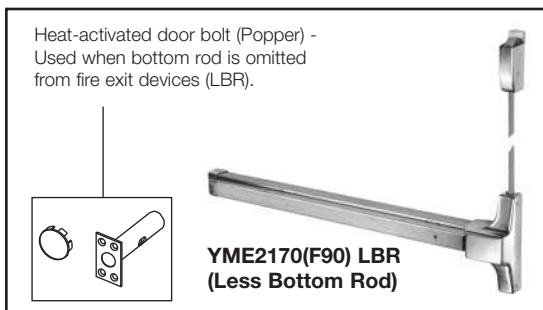

features

- Designed for wide stile and flush doors
- Mechanisms made of heavily electroplated high-grade steel and non-ferrous materials provide sturdy construction and superior protection against corrosion
- Interlocking top strike and latch mounting plate for added stability
- Handed, specify hand (field reversible)
- Available less bottom rod (LBR option)

applications

- Pairs of doors
- Double egress
- Metal, wood, or composite door materials

specifications

Door Opening Width: -36 for 30" - 36" (76cm - 91cm) doors
-42 for 36" - 42" (91cm - 107cm) doors
-48 for 42" - 48" (107cm - 122cm) doors

Door Opening Height: Standard door height 7' (213mm), with the device at 39-5/16" (100cm) from floor. Optional heights specify suffix -8, -9, -10.

Door Thickness: 1-3/4" (44mm) standard. Refer to page 10 for other door thicknesses.

Minimum Stile Width: 4-1/2" (114mm)

Projection: 2-1/2" (64mm) active, 1-3/4" (44mm) depressed

Trims: 210F series utility trim, 420F series escutcheon trim, 440F series rose trim.

Dogging: Hex key dogging supplied standard on panic devices.





Options: Shim Kit #223, Sex Nuts and Bolts, Bottom Pullman Latch (panic only), Less Bottom Rod (LBR), -8, -9, -10 opening height, rod extensions.

Finishes: 630, 689, 691, 693, 695

Warranty: 1-year limited

outside trim

lever designs

AU Augusta	CR Carmel	MO Monroe	PB Pacific Beach
			
Projection: 2-5/16" (69mm)	Projection: 2-7/8" (73mm)	Projection: 2-3/16" (71mm)	Projection: 2-3/4" (70mm)

440F series rose trim

- Certified ANSI/BHMA A156.3, Grade 1. 
- 440F rose trim for stock doors (161 Prep).
- 1-3/4" (44mm) door standard. For doors thru 2-1/4" (57mm) or shim-mounted devices, specify on order.
- Accepts component cylinders. See pages 14-15.
- Finishes: 612, 613, 626, 630, 689, 691, 693, 695.
- "B" trim prefix – Lever trim accepting small format interchangeable cores (SFIC). Specify 6- or 7-pin.
(Example: B-AU446F)
- One-year warranty.
- Ordering example: AU446F x RHR x 693.

Applications	AU		PB		
	Nightlatch Access by Key	Classroom	Dummy Trim Free Wheeling Lever	Passage Lever	Dummy Trim Rigid Lever
YME2100(F) YME2110(F) YME2170(F90)	441F	446F	448F	448F	449F
ANSI	03	08	02	14	02

outside trim

420F series wide escutcheon trim

- Certified ANSI/BHMA A156.3, Grade 1. **BHMA CERTIFIED**
- Through-bolted. 1-3/4" (44mm) door standard. For doors thru 2-1/4" (57mm) or shim-mounted devices, specify on order.
- Dimensions: 2-1/2" x 9-1/2" x 1/4" (64mm x 241mm x 6mm).
- For rim cylinders, see pages 14-15.
- Finishes: 612, 613, 626, 630, 689, 691, 693, 695.
- One-year warranty.
- Ordering Example: PB428F x LHR x 689.

Applications	Cylinder	Exit Only Blank Plate	Nightlatch	Classroom/Storage room	Nightlatch	Dummy Free Wheeling	Passage	Dummy Rigid Lever
YME2100(F) YME2110(F) YME2170(F90)	Rim	420F	421F*	426F	427F*	428F	428F	429F
ANSI		01	03	08/09	03	02	14	02

***Not recommended for use with YME2110(F) surface vertical rod exit devices.**
Note: 09 and Free Wheeling 02 achieved with single trim modification at installation.

210F series trim

- Through-bolted. 1-3/4" (44mm) door standard. For doors thru 2-1/4" (57mm) or shim-mounted devices, specify on order.
- Plate Dimensions: 3-1/2" x 3-3/4" x 3/32" (89mm x 95mm x 2mm).
- Finger Pull Dimensions: 3-1/2" x 6-3/4" x 1/8" (89mm x 171mm x 3mm).
- For rim cylinders, see pages 14-15.
- Finishes: 689, 691, 693, 695.
- One-year warranty.

Application	Cylinder	Nightlatch Access by Key	Dummy Trim Pull Plate	Nightlatch Cylinder x Pull
YME2100(F) YME2110(F) YME2170(F90)	Rim	213F*	214F	217F*
ANSI		03	02	03

***Not recommended for use with YME2110(F) surface vertical rod exit devices.**

strikes

rim devices

<p>757F Standard YME2100(F)</p>	<p>793 Optional strike for double door applications without a mullion.</p>

vertical rod devices - top strikes

<p>791 Standard YME2110(F)</p>	<p>726 Standard YME2170(F90)</p>	<p>797 Optional bracket for SVR top strike in flush transom opening.</p>

vertical rod devices - bottom strikes

<p>790 Standard YME2110(F) and YME2170(F90).</p>	<p>794 Optional floor strike for fire openings using saddle threshold or flush floor mount. Must use for fire openings with thresholds.</p>	<p>702 Optional floor strike for bottom Pullman latch option</p>

accessories

shim kits

Shim kits are available for devices on doors with interfacing molding. Each shim kit contains:

- 2 sets of 1/8" shims (shim up to 1/4")
- Longer fasteners
- Longer connecting bar for the trim
- Installation instructions

223 – Shim Kit for YME2100(F) Series rim exit devices

224 – Shim Kit for YME2110(F) Series surface vertical rod exit devices

extension rods

YME2110 surface vertical rod devices are supplied standard for 7' (213cm) standard. Rods may be field cut or used with extension rods for other heights. To order, specify:

Model Number	Length
2010-2	2" (51mm)
2010-6	6" (153mm)
2010-12	12" (305mm)
2010-24*	24" (610mm)

*Used for 10' door applications with YME2170(F90).

specialty fasteners

Sex Nuts:

Required for wood, composite or unreinforced metal doors. To order specify:

- SN-104 – pack of (4) 10-24 sex nuts for all fire rim exits
- SN-134 – pack of (4) 1/4-20 sex nuts for all devices

Wood Door Fasteners:

For solid core wood doors, permitted if pilot holes are used to install screws. Consult the factory for availability.

Torx® Security Screws available for factory product orders.

long tailpiece kit

Long tailpiece kit for all series trim, up to 4-1/2" thick doors. Specify part number to order.

Door Thickness	Trim Type	Part Number
2" - 2-1/2"	All Trim	000-0000-3955-000
2-1/2" - 3-1/2"	420F Series Lever Trim (only)	81-9500-1633-000
3-1/2" - 4-1/2"	420F Series Lever Trim (only)	81-9500-1634-000

bottom pullman latch

Optional bottom Pullman latch available for panic-listed vertical rod exit devices. To order with devices, specify "BPL."



mullions

M200(F) removable mullion

M200(F) mullions are for use with YME2100(F) Series exit devices. Mullions may be field cut to fit opening. Red primer finish.

- **M200 Removable Mullion**
For Panic Exits. Tubular steel, 2" x 3" (51mm x 76mm). Specify 7', 8', or 10'.
- **M200F Removable Mullion**
For Fire Exits. Tubular steel, 2" x 3" (51mm x 76mm). Specify 7' or 8'.

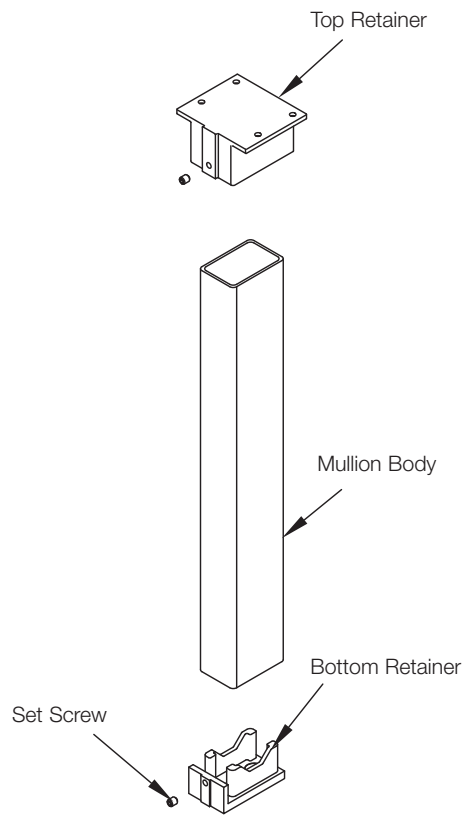

M200(F) options

- **M203 Spacer Block**
Recommended for double rabbeted frames where the stop face width is less than the mounting hole spacing or for applications with 5-3/4" (146mm) or less door frames.

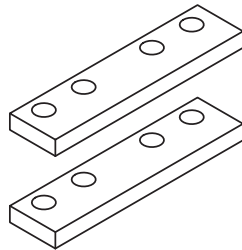

- **M204 Angle Bracket**
Recommended for any header configuration with less than 3" (76mm) of mounting surface.

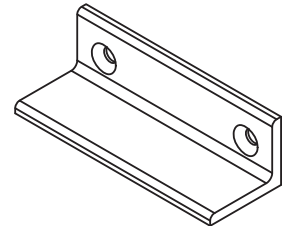

mullions

keyed removable mullion (KRM)

Keyed removable mullions are for use with YME2100(F) Series exit devices. They are designed for simple removing when an unobstructed large opening is required and easy replacement and locking to maintain the integrity of the opening.

- KRM200 Keyed Removable Mullion for Panic Exits. Specify 7', 8', or 10'.
- KRM200F Keyed Removable Mullion for Fire Exits. Specify 7' or 8'.

krm features

- Easy cylinder installation.
- Mullion automatically relocks when reinstalled without the use of the cylinder key.
- When ordering, add KR prefix to mullion, example: KRM200 and KRM200F.

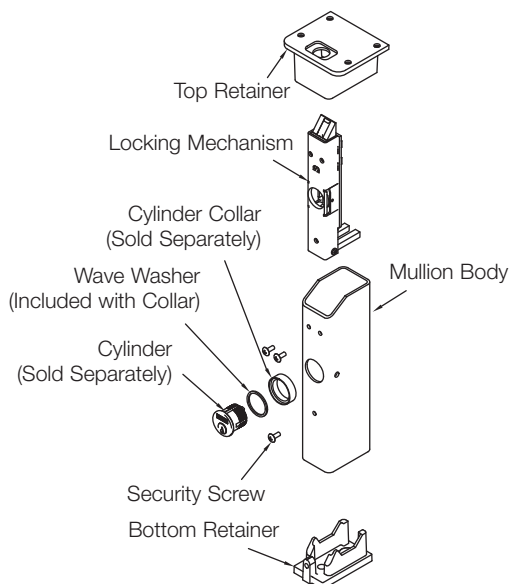

krm options

- **M203 Spacer Block**

Recommended for double rabbeted frames where the stop face width is less than the mounting hole spacing or for applications with 5-3/4" (146mm) or less door frames.

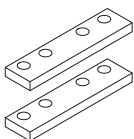

- **M204 Angle Bracket**

Recommended for any header configuration with less than 3" (76mm) of mounting surface.

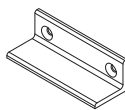

krm cylinders

As with any exit device trim, you must order a cylinder and collar if one is required. The Yale® keyed removable mullion accepts a mortise cylinder. Refer below and to pages 14-15 for details.

krm collars

Cylinder Model #	Length	Collar Requirement
2153 or 2553	1-1/4"	1765.312
A620 or K660	1-1/4"	1765.406
	1-3/8"	1765.563



alarm kit

The 2116 Alarm Kit affords a simple and economical means of providing the YME2100 Series exit device with an audible alarm. This alarm is battery operated and completely self-contained. It serves as the hinge stile mounting bracket for the YME2100 series exit device and operates when the device flat bar is depressed. It can be retrofitted to any existing YME2100 series exit device. The Alarm Kit has a non-ferrous cover which is spray finished to match the exit device.



features

Complete Self-Contained:	Kit incorporates a solid-state circuit with electronically generated alarm. Powered by the supplied 9 VDC transistor battery.
Easy Installation:	Alarm kit requires only drilling and tapping 3 holes. Can be retrofitted to existing YME2100 series exit devices.
Loud Alarm Db Level:	Alarm sounds loud, piercing tone (measures 90 to 96 decibels (Db) at 10 feet).
Cylinder Arm/Disarm:	A mortise cylinder (not supplied unless specified) arms and disarms the alarm. A Red LED indicator will illuminate every 30 seconds when the alarm is armed and in stand-by.
Arming Delay/Authorized Egress:	10-second delay (after arming) permitting egress (by turning key clockwise).
Tamper Resistant:	Removing cover will activate alarm. Battery is protected by a hardened steel shield. Alarm will continue to sound even when alarm switch wires are cut.
Nuisance Alarm:	Factory preset for instant alarm. Selectable feature for alarm to sound when exit device touchbar is depressed for more than 2 seconds. (This feature is selected by a switch on the circuit board.)
Activation:	Alarm is armed by turning key clockwise. Low audible chirp indicates alarm has been activated. Alarm will sound when the exit device touchbar is depressed. Factory preset for standard alarm mode which automatically resets after 5 minutes.
Continuous Alarm Mode:	Alarm sounds continuously when the exit device touchbar is depressed. Alarm must be manually reset by keyswitch. (This feature is selected by a switch on the circuit board.)
Low Battery Drain:	On stand-by conditions (with few or no alarm activations) battery life is approximately one year.
Low Power Battery Indicator:	The electronic circuit will sound an audible beep every 30 seconds when the battery power drops below a safe operating level.
Warning Decal:	Alarm Kit is complete with a decal, warning user of the alarm, "EMERGENCY EXIT – ALARM WILL SOUND".

technical details

- Minimum Door Width:** 36"
- Case Dimensions:** 2-1/2" high, 2-3/8" deep, 7" long
- Material:** Chassis, stainless steel; cover, non-ferrous.
- Battery:** 9 VDC battery
- Cylinder:** Mortise cylinder (refer to pages 14-15 for details). Clockwise turn arms the alarm; counterclockwise turn disarms or silences the alarm. (Cylinder not included.)
- Finishes:** 630, 689, 691, 693, 695
- Ordering:** Specify 2116 x finish

stand-alone door alarm

The SDA16 stand-alone battery operated door alarm is designed to continually monitor the status of a door. When the door is opened without authorization, an alarm is triggered to alert the security violation. This alarm features a Peizo horn which blasts a deafening 105+ decibels to alert the violation.

This unit is ideal for emergency doors as well as stairwell doors and rear exit doors in retail environments. The unit, which can also be hardwired, easily complements existing hardware, making any opening alarmed. The SDA16 door alarm is typically mounted on the interior of the door frame or door and is paired with a magnet mounted on the opposing side of the door gap.





features

- Dimensions: 8.3"L x 3.1"W x 2.0"D (210mm L x 79mm W x 52mm D)
- Non-handed unit (field reversible)
- Unit powered by 9V battery
- Unit can be hardwired by using WH-11 wire harness and 784 power supply
- No battery is required in unit with hard-wire option – if power is lost, optional gel-cell battery in power supply will give approximately 10,000 operations
- Reverse battery protection safeguards the unit if the battery is incorrectly installed
- A low-voltage battery is indicated by an audible signal every 30 seconds
- Piezo horn blasts at 105+ decibels if the door is used with out proper authorization
- The LED will flash every 30 seconds, indicating either the unit is armed or, if under auto reset, that the door has been violated
- Various field-adjustable features by dip switch including automatic alarm reset, REX and passage time delay, and LED color preference
- A tamper switch provides instantaneous signal to sound horn in the event the cover is removed. Horn will sound until the unit is reset by the key or remote reset/arm switch
- Conformally coated electronics for weather resistance
- Cover is held in place by cam lock which protects mounting screws, electrical system and internal sensors
- Accepts external cylinder (not included, must be specified)
- Accepts standard mortise cylinders (not included, must be specified)

cylinders and accessories

- 784 Power supply (9VDC) — includes plug-in wall transformer
- Plug-in wall transformer with 12' cable assembly (part no. 00-0000-3425)
- Gel-cell battery — optional for use with 784 power supply (part no. 00-0000-3426)
- WH-11 Wire harness for remote power and remote unlock
- Mortise cylinder for unit
- Rim cylinder for outside control

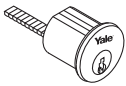
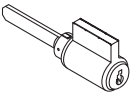
cylinders

Illustration	Type	Model Number	Number of Pins
	Cylinder used for trim series 210F and 420F, and outside for SDA16 (PARA keyway, 6-pin only)	1109	6
	Cylinder used for trim series 440F (PARA keyway, 6-pin only)	1802	6
	Cylinder used for KRM200(F), 2116 alarm, and SDA16 alarm (PARA keyway, 6-pin only)	2153	6





keying

All cylinders furnished standard 6-pin, keyed random in Yale® PARA keyway, pinned to Yale .019" specification. Each cylinder furnished with two nickel silver keys.

options

Cylinders available 0-bitted, keyed alike, master keyed or construction master keyed upon request (PARA keyway only, cylinders are not available in any other Yale keyways).

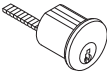
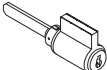
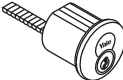
competitor keyway cylinders/cores

Illustration	Type	Model Number	Number of Pins (Specify)
	Best® Keyway Core. Available keyed random, master keyed or uncombined. Specify keyway A, B, C, D, E, F, G, H, J, K, L or M	A600	6 or 7
	Schlage® C Keyway Cylinder. For use with trim series 210F and 420F, and outside for SDA16. Available 0-bitted or keyed random.	2109	6
	Schlage® C Keyway Cylinder. For use with 440F series trim. Available 0-bitted or keyed random.	2802	6
	Rim SFIC Cylinder. Includes Best Keyway Core. For use with 210F and 420F series trim. Available keyed random, master keyed or uncombined. Specify keyway A, B, C, D, E, F, G, H, J, K, L or M.	A640	6 or 7 Specify Length: 1-1/4" (6-pin only) 1-3/8" (6- or 7-pin)
	Mortise SFIC Cylinder. Includes Best® Keyway Core. For use with KRM200(F), 2116 alarm, and SDA16 alarm. Available keyed random, master keyed or uncombined. Specify keyway A, B, C, D, E, F, G, H, J, K, L or M.	A620	6 or 7 Specify Length: 1-1/4" (6-pin only) 1-3/8" (6- or 7-pin)
	Schlage® C Keyway Cylinder. For use with KRM200(F), 2116 alarm, and SDA16 alarm and 2116 alarm. Available 0-bitted or keyed random.	2553	6

small format interchangeable core (SFIC)

Model/ Prefix	Description	Length	Number of Pins (Specify)		Ordering Example
			6-Pin	7-Pin	
B-	Prefix for cylindrical lever with SFIC prep. Less core. For use with 440F series trim.	—	—	—	B-AU446F x 693
K680	Rim SFIC housing only. For use with 210F and 420F series trim.	1-1/4"	X	—	AU426F x K680 x 1-1/4" x 693
		1-3/8"	X	X	
K660	Mortise SFIC housing only. For use with Key Removable Mullion.	1-1/4"	X	—	KRM200F x K660 x 1-1/4"
		1-3/8"	X	X	



how to order

YME2	1	X	0	Suffix	-XX	Outside Trim	Finish	Other Info
		Third Digit: "0" - Rim Device "1" - SVR Device "7" - SVR Device over 8'		Trim Suffix: No Suffix - Panic label "F" - Fire label	Size: (DOW=Door Opening Width) "36" - 30" to 36" (76cm to 91cm) "42" - 36" to 42" (91cm to 107cm) "48" - 42" to 48" (107cm to 122cm)	Trim Model Number See pages 7-8	See page 2	Other Information: Door Hand - RHR or LHR (SVR or Lever Escutcheon Trim only). Devices are field reversible. SN-134, 1/4-20 Sex Nuts (pack of 4). SN-104, 10-24 Sex Nuts (pack of 4). Door Thickness: over 1-3/4" (45mm). Rod Extensions: (quantity) 2010-2 (quantity) 2010-6 (quantity) 2010-12 Shim Kits: (quantity) 223 (quantity) 224 Optional Strike (page 9) Removable Mullion: M200 (Panic) M200F (Fire) KRM200 (Panic) KRM200F (Fire) Factory Keying Bottom Pullman Latch (SVR Devices) Alarm Kit: 2116

Notes:

- It is recommended that exit devices and trim for the same opening be ordered together.
- Standard product is for 1-3/4" (44mm) reinforced metal doors.
- Accessories detached from the device and trim should be specified separately.

www.yalecommercial.com

Yale Commercial Locks and Hardware

Address: 100 Yale Avenue, Lenoir City, TN 37771-3226 USA

Tel: 1-800-438-1951 • Fax: 1-800-338-0965 • www.yalecommercial.com

Yale Residential Security Products, Inc.

Address: 100 Yale Avenue, Lenoir City, TN 37771-3226 USA

Tel: 1-800-438-1951 • Fax: 1-800-338-0965 • www.yalelock.com

ASSA ABLOY Door Security Solutions - Canada

Address: 160 Four Valley Drive, Vaughan, Ontario L4K4T9 Canada

Tel: 1-800-461-3007 • Fax: 1-905-738-2478 • www.assaabloy.ca

ASSA ABLOY NA International

www.aanai.com

Yale® is a registered trademark of Yale Security, Inc., an ASSA ABLOY Group company. YM Series™ is a trademark of Yale Security, Inc., an ASSA ABLOY Group company. Other products' brand names may be trademarks or registered trademarks of their respective owners and are mentioned for reference purposes only. These materials are protected under U.S. copyright laws. All contents current at time of publication. Yale Security, Inc. reserves the right to change availability of any item in this catalog, its design, construction, and/or its materials. Copyright © 2008, Yale Security, Inc., an ASSA ABLOY Group company. All rights reserved. Reproduction in whole or in part without the express written permission of the Yale Security, Inc., an ASSA ABLOY Group company, is prohibited.

YALE, with its unique global reach and range of products, is the world's favorite lock.

ASSA ABLOY is the global leader in door opening solutions, dedicated to satisfying end-user needs for security, safety and convenience.

42609-8/08R